

**INSTALLATION INSTRUCTIONS****Single Package Heat Pump - 2 Stage, R-410A****IMPORTANT****ATTENTION INSTALLERS:**

It is your responsibility to know this product better than your customer. This includes being able to install the product according to strict safety guidelines and instructing the customer on how to operate and maintain the equipment for the life of the product. Safety should always be the deciding factor when installing this product and using common sense plays an important role as well. Pay attention to all safety warnings and any other special notes highlighted in the manual. Improper installation of the furnace or failure to follow safety warnings could result in serious injury, death, or property damage.

These instructions are primarily intended to assist qualified individuals experienced in the proper installation of this appliance. Some local codes require licensed installation/service personnel for this type of equipment. Please read all instructions carefully before starting the installation. Return these instructions to the customer's package for future reference.

**DO NOT DESTROY. PLEASE READ CAREFULLY AND KEEP IN A SAFE PLACE FOR FUTURE REFERENCE.**

<b>Important Safety Information .....</b>	<b>3</b>	<b>Startup &amp; Adjustments .....</b>	<b>11</b>
<b>Requirements &amp; Codes .....</b>	<b>4</b>	Pre - Start Checklist .....	11
<b>General Information .....</b>	<b>4</b>	Start - Up Procedure .....	11
Before You Install this Unit.....	4	Air Circulation.....	11
Locating the Heat pump .....	4	System Heating.....	11
Air Duct System .....	4	System Cooling.....	11
Unconditioned Spaces .....	5	Short Cycle Protection .....	11
<b>Heat Pump Installation.....</b>	<b>5</b>	Emergency Heat .....	11
Unpacking the Unit .....	5	Adjustment of Refrigerant Charge.....	11
Minimum Clearances.....	5	Charging the Unit in AC Mode .....	11
Service Access Clearances .....	5	Charging the Unit in Heat Mode.....	12
Clearances to Combustible Materials .....	5	Forced Defrost Mode (Field Test).....	12
Installing Return & Supply Air Collars .....	5	Anti Short Cycle Timer Test.....	12
Return Duct .....	5	Heating Mode.....	12
Supply Duct .....	5	Cooling Mode.....	12
Locating & Installing the Return Air Assembly.....	5	<b>Component Functions .....</b>	<b>12</b>
Locating & Installing the Supply Dampers.....	6	Low Pressure Switch.....	12
Condensate Drainage .....	6	High Pressure Switch.....	12
<b>Electrical Connections.....</b>	<b>7</b>	<b>Unit Maintenance.....</b>	<b>12</b>
Pre - Electrical Checklist .....	7	<b>Figures &amp; Tables .....</b>	<b>13</b>
Line Voltage.....	7	Figure 8 - Unit Dimensions .....	13
Grounding.....	7	Table 2 - Physical Data .....	13
Overcurrent Protection .....	7	Refrigerant Charging Charts - Cooling Mode.....	14
Blower Speed .....	8	Figure 9 - Charging Chart for 2 Ton Units .....	14
2 - Speed Outdoor Fan Motor .....	8	Figure 10 - Charging Chart for 3 Ton Units .....	14
Ambient Sensor Mounting.....	8	Figure 11 - Charging Chart for 4 Ton Units .....	15
Demand Defrost Control.....	9	Figure 12 - Charging Chart for 5 Ton Units .....	15
Thermostat Connections .....	9	Wiring Diagrams.....	16
Electric Heat Package .....	10	Figure 13 - W.D. for 2 & 3 Ton Units .....	16
		Figure 14 - W.D. for 4 & 5 Ton Units .....	17

## IMPORTANT SAFETY INFORMATION

Please read all instructions before servicing this equipment. Pay attention to all safety warnings and any other special notes highlighted in the manual. Safety markings are used frequently throughout this manual to designate a degree or level of seriousness and should not be ignored. **WARNING** indicates a potentially hazardous situation that if not avoided, could result in personal injury or death. **CAUTION** indicates a potentially hazardous situation that if not avoided, may result in minor or moderate injury or property damage.

---

### **WARNING:**

---

#### **ELECTRICAL SHOCK, FIRE OR EXPLOSION HAZARD**

Failure to follow safety warnings exactly could result in serious injury or property damage.

Improper servicing could result in dangerous operation, serious injury, death or property damage.

- Before servicing, disconnect all electrical power to the indoor blower.
  - When servicing controls, label all wires prior to disconnecting. Reconnect wires correctly.
  - Verify proper operation after servicing.
- 

---

### **WARNING:**

---

These units are fully charged with R-410A refrigerant and ready for installation. When a system is installed according to these instructions, no refrigerant charging is required. If repairs make it necessary for evacuation and charging, it should only be attempted by qualified, trained personnel thoroughly familiar with this equipment. Some local codes require licensed installation service personnel to service this type of equipment. Under no circumstances should the homeowner attempt to install and/or service this equipment. Failure to comply with this warning could result in equipment damage, personal injury, or death.

---

---

### **WARNING:**

---

Do not place combustible material on or against the unit cabinet. Do not place combustible materials, including gasoline and any other flammable vapors and liquids, in the vicinity of the unit.

---

---

### **WARNING:**

---

**PROPOSITION 65 WARNING:** This product contains fiberglass wool, a product known to the state of California to cause cancer. Disturbing the insulation of this product during installation, maintenance, or repair will expose you to fiberglass wool.

- Breathing this material may cause respiratory irritations or may cause lung cancer.
  - Fiberglass wool may also cause eye irritation, skin sensitization, or other allergic responses in susceptible individuals.
  - Always wear goggles, disposable gloves, long sleeved shirt, and appropriate breathing protection when working near this insulation. If contact with skin occurs, wash immediately with soap and water. In case of contact with eyes, flush immediately with water for at least 15 minutes. Contact a physician if needed.
- 

---

### **WARNING:**

---

The information listed below and on the next page must be followed during the installation, service, and operation of this unit. Unqualified individuals should not attempt to interpret these instructions or install this equipment. Failure to follow safety recommendations could result in possible damage to the equipment, serious personal injury or death.

---

- Before beginning the installation, verify that the unit model is correct for the job. The unit model number is printed on the data label. Follow all precautions in the literature, on tags, and on labels provided with the equipment. Read and thoroughly understand the instructions provided with the equipment prior to performing the installation and operational checkout of the equipment.
- Installation of equipment may require brazing operations. Installer must comply with safety codes and wear appropriate safety equipment (safety glasses, work gloves, fire extinguisher, etc.) when performing brazing operations.
- Use caution when handling this appliance or removing components. Personal injury can occur from sharp metal edges present in all sheet metal constructed equipment.

- Follow all precautions in the literature, on tags, and on labels provided with the equipment. Read and thoroughly understand the instructions provided with the equipment prior to performing the installation and operational checkout of the equipment.
- The installer should become familiar with the units wiring diagram before making any electrical connections to the unit. See the unit wiring label or Figures 13 & 16 (pages 16 & 17).

## REQUIREMENTS & CODES

- All electrical wiring must be completed in accordance with local, state & national codes and regulations and with the National Electric Code (ANSI/NFPA 70) or in Canada the Canadian Electric Code Part 1 CSA C.22.1.
- The installer must comply with all local codes and regulations which govern the installation of this type of equipment. Local codes and regulations take precedence over any recommendations contained in these instructions. Consult local building codes and the National Electrical Code (ANSI C1) for special installation requirements.
- This equipment contains liquid and gaseous refrigerant under high pressure. Installation or servicing should only be performed by qualified trained personnel thoroughly familiar with this type equipment.
- Air Ducts must be installed in accordance with the standards of the National Fire Protection Association "Standards for Installation of Air Conditioning and Ventilation Systems" (NFPA 90A), "Standard for Installation of Residence Type Warm Air Heating and Air Conditioning Systems" (NFPA 90B), these instructions, and all applicable local codes.
- Consult Table 1 (page 8), and the rating plate for the proper circulating air flow and temperature rise. It is important that the duct system be designed to provide the correct flow rates and external pressure rise. An improperly designed duct system can result in nuisance shutdowns, and comfort or noise issues.
- This unit is designed for outdoor installations only and should be positioned as described in Locating the Heat Pump.

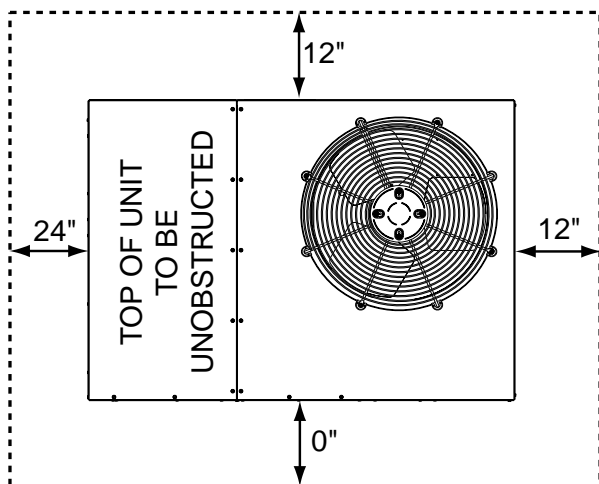

Figure 1. Minimum Unit Clearances

## GENERAL INFORMATION

Single packaged heat pumps are ready for easy and immediate installation and can be readily connected into the high static duct system of a home. This unit is completely assembled, wired, and run tested at the factory. The only connections needed for installation are the supply and return ducts, the line voltage, and thermostat wiring. Use of components other than those specified may invalidate AHRI Certification, Code Agency Listing, and limited warranty on the air conditioner.

### Before You Install this Unit

- ✓ The cooling load of the area to be conditioned must be calculated and a system of the proper capacity selected. It is recommended that the area to be conditioned be completely insulated and vapor sealed.
- ✓ Check the electrical supply and verify the power supply is adequate for unit operation. If there is any question concerning the power supply, contact the local power company.
- ✓ All units are securely packed at the time of shipment and upon arrival should be carefully inspected for damage prior to installing the equipment at the job site. Verify coil fins are straight. If necessary, comb fins to remove flattened or bent fins. Claims for damage (apparent or concealed) should be filed immediately with the carrier.
- ✓ Please consult your dealer for maintenance information and availability of maintenance contracts. Please read all instructions before installing the unit.

### Locating the Heat Pump

- Survey the job site to determine the best location for mounting the outdoor unit.
- Choose an appropriate location that minimizes the length of the supply and return air ducts.
- Overhead obstructions, poorly ventilated areas, and areas subject to accumulation of debris should be avoided.
- Sufficient clearance for unobstructed airflow through the outdoor coil must be maintained in order to achieve rated performance. See Figure 1 for minimum clearances to obstructions.
- Consideration should also be given to availability of electric power, service access, noise, and shade.

### Air Duct System

Air ducts must be installed in accordance with the standards of the National Fire Protection Association "Standard for Installation of Air Conditioning and Ventilation Systems" (NFPA 90A), "Standard for Installation of Residence Type Warm Air Heating and Air Conditioning Systems" (NFPA 90B), these instructions, and all applicable codes. NFPA publications are available by writing to: National Fire Protection Association, Batterymarch Park, Quincy, ME 02269 or visit [www.NFPA.org](http://www.NFPA.org) on the web.

- Design the duct work according to methods described by the Air Conditioning Contractors of America (ACCA).
- The supply duct system, including the number and type of registers, will have much more effect on the performance of the system than any other factor. The

duct must be sufficiently large to conduct an adequate amount of air to each register. See Figure 3 (page 6).

- Duct work should be attached directly to the unit flanges for horizontal applications.
- For highly resistive duct systems it may be necessary to add an additional return air duct and or supply to achieve maximum performance and prevent coil icing and refrigerant flood back

Unconditioned Spaces

All duct work passing through unconditioned space must be properly insulated to minimize duct losses and prevent condensation. Use insulation with an outer vapor barrier. Refer to local codes for insulation material requirements.

**The heat pump system will not cool or heat the home if air is lost to the outside through leaks in the duct system. Ducts that are collapsed or restricted by foreign objects will also prevent adequate air flow.**

**HEAT PUMP INSTALLATION**

**Unpacking the Unit**

It is recommended that the unit be unpacked at the installation site to minimize damage due to handling.

**⚠ CAUTION:**

**Do not tip the unit on its side. Oil may enter the compressor cylinders and cause starting trouble. If unit has been set on its side, restore to upright position and do not run for several hours. Then run unit for a few seconds. Do this three or four times with five minutes between runs.**

1. Remove the bands from around the unit.
2. Unfold the top and bottom cap flanges.
3. Carefully remove the top cap and tube.

**Minimum Clearances**

Minimum clearances **MUST** be maintained from adjacent structures to provide room for proper servicing and air circulation. **DO NOT** install unit in a confined or recessed area that will allow discharge air from the unit to re-circulate into the condenser air inlet, through the coil. See Figure 1.

Service Access Clearances

Blower access panel side .....	24"
Electrical compartment access panel side .....	12"
Clearance between overhang and top of unit .....	72"
Clearance around condenser coil area to wall or shrubs (excludes duct panel side) .....	12"

Clearances to Combustible Materials

Supply and return air ducts .....	0"
Duct connection side .....	0"

**Installing Return & Supply Air Collars**

If the supply and return collars are supplied with the unit, they will be located in the supply duct. They can be easily positioned over the unit openings (Figure 2) and secured with sheet metal screws.

- The diameter of the return duct collar is 14".
- The diameter of the supply duct collar is 12".
- Before permanently installing the collars, it is recommended you pre-fit them over the openings first to determine best fit and alignment.

Return Duct

1. Align the slots with the holes in the collar and install two screws.
2. Position the collar over the opening and align the four holes in the collar with the four dimples or holes (depending on unit model) in the panel.
3. Using self-drilling screws (10-16x.5) attach the collar to the rear panel.

Supply Duct

1. Position the supply duct collar so the edge of the unit opening fits between the flange and the bead.
2. Overlap the collar ends keeping the small screw holes underneath.
3. Align the holes in the crimped area and install one screw. **NOTE:** It may be necessary to loosen the four screws that hold the transition duct in order to install the supply fitting. Re-tighten when installation is complete.
4. Tap collar (if necessary) to ensure engagement with unit opening and install second screw.
5. Tighten first screw and rotate collar clockwise so joint is near three o'clock position.

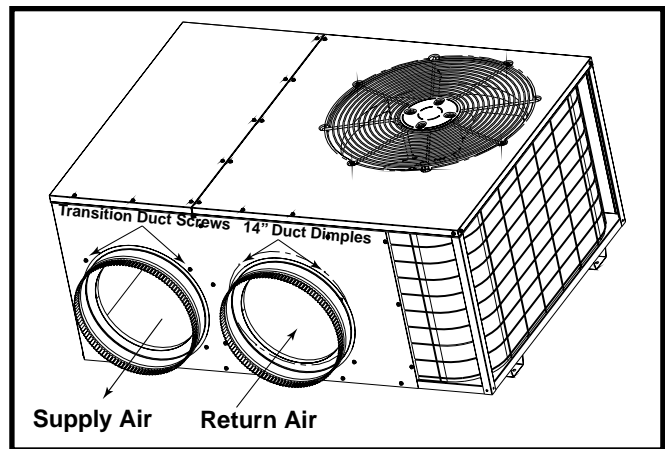

**Figure 2. Return & Supply Air Collars**

**Locating & Installing the Return Air Assembly**

To simplify installation, locate and install the return air assembly first. If desired, the return opening can be located inside a closet with louvered doors that has an open area equal to or greater than a 12" x 20" grille. The return air grille can be placed in the wall of a closet and the air ducted into the filter box through a boxed-in area at the closet floor level. **Make sure the filter is readily accessible.**

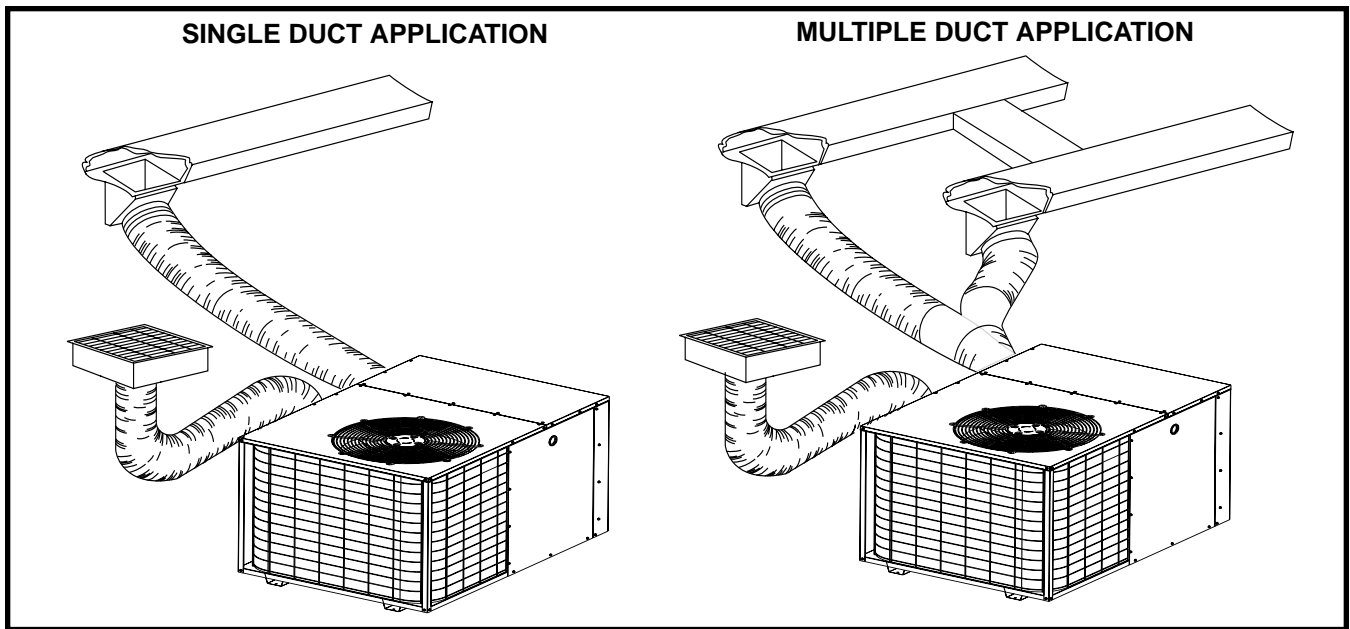

Figure 3. Typical Duct Applications

### Locating & Installing the Supply Damper(s)

#### **⚠ CAUTION:**

If installing this air conditioning system in conjunction with a furnace, a damper must be installed in the furnace base assembly to prevent cold air from being discharged around the heat exchanger. Damage to the heat exchanger and asphyxiation may occur if a damper is not installed.

Check with the furnace manufacturer for damper requirements. Failure to install the required furnace damper may invalidate code agency listing and limited warranty on the furnace.

### Condensate Drainage

A 3/4" condensate fitting extends out of the side of the unit as shown in Figure 4. The drain trap, shipped in the electrical compartment, must be installed to prevent water from collecting inside the unit.

1. Thread the elbow provided with the unit into the drain connection until hand tight.
2. Connect the condensate tubing onto the fitting, forming a trap near the drain connection.
3. Route the condensate tube from the trap to a suitable drain. **NOTE:** For proper drainage, make sure the trap is level to the ground and tubing outlet is below trap level.

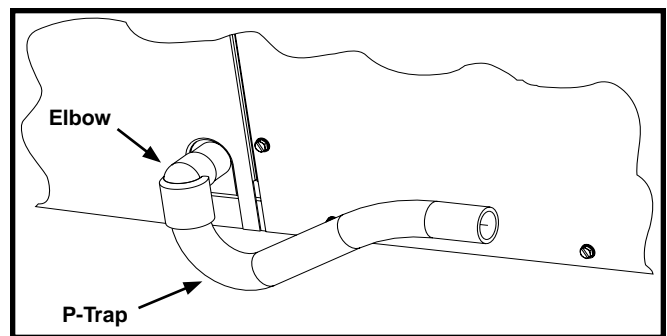

Figure 4. Drain Trap

## ELECTRICAL CONNECTIONS

### **⚠ WARNING:**

**To avoid electric shock, personal injury, or death, turn off the electric power at the disconnect or the main service panel before making any electrical connections.**

- Electrical connections must be in compliance with all applicable local codes and ordinances, and with the current revision of the National Electric Code (ANSI/NFPA 70).
- For Canadian installations the electrical connections and grounding shall comply with the current Canadian Electrical Code (CSA C22.1 and/or local codes).

#### **Pre-Electrical Checklist:**

- ✓ Verify that the voltage, frequency, and phase of the supply source match the specifications on the unit rating plate.
- ✓ Verify that the service provided by the utility is sufficient to handle the additional load imposed by this equipment. refer to the unit wiring label for proper high and low voltage wiring.
- ✓ Verify factory wiring is in accordance with the unit wiring diagram (Figures 13 & 14, pages 16 & 17). Inspect for loose connections.

#### **Line Voltage**

- It is recommended that the line voltage to the unit be supplied from a dedicated branch circuit containing the correct fuse or circuit breaker for the unit.
- **An electrical disconnect must be located within sight of and readily accessible to the unit.** This switch shall be capable of electrically de-energizing the outdoor unit. See unit data label for proper incoming field wiring. Any other wiring methods must be acceptable to authority having jurisdiction.
- Provide power supply for the unit in accordance with the unit wiring diagram, and the unit rating plate.

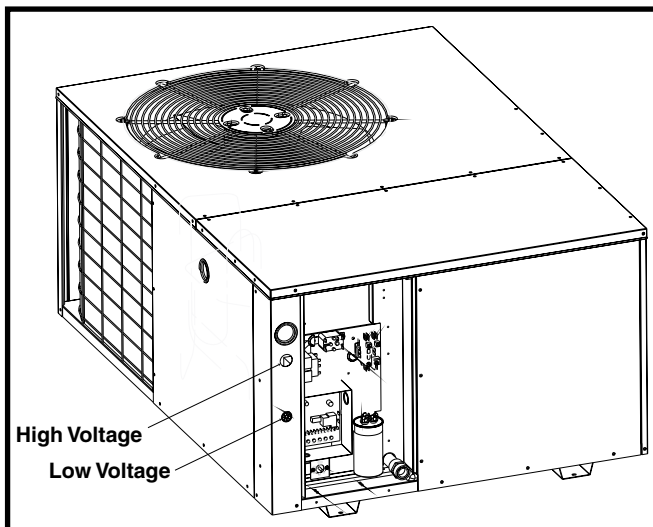

**Figure 5. Power Entry**

- Connect the line-voltage leads to the terminals on the contactor inside the control compartment. Extend leads through power wiring hole (Figure 5). Connect L1 & L2 directly to the contactor.
- Use only copper wire for the line voltage power supply to this unit. Use proper code agency listed conduit and a conduit connector for connecting the supply wires to the unit. Use of rain tight conduit is recommended.
- See the unit wiring label for proper high and low voltage wiring. Make all electrical connections in accordance with all applicable codes and ordinances.

### **⚠ CAUTION:**

**Label all wires prior to disconnection when servicing controls. Wiring errors can cause improper and dangerous operation. Verify proper operation after servicing.**

- Units are shipped from the factory wired for 240 volt transformer operation. For 208V operation, remove the lead from the transformer terminal marked 240V and connect it to the terminal marked 208V.

#### **Grounding**

### **⚠ WARNING:**

**The unit cabinet must have an uninterrupted or unbroken electrical ground to minimize personal injury if an electrical fault should occur. Do not use gas piping as an electrical ground!**

This unit must be electrically grounded in accordance with local codes or, in the absence of local codes, with the National Electrical Code (ANSI/NFPA 70) or the CSA C22.1 Electrical Code. Use the grounding lug provided in the control box for grounding the unit.

#### **Overcurrent Protection**

Overcurrent protection must be provided at the branch circuit distribution panel and sized as shown on the unit rating label and according to applicable local codes. Generally, the best fuse or breaker for any heat pump is the smallest size that will permit the equipment to run under normal usage and provide maximum equipment protection. Properly sized fuses and breakers also prevent nuisance trips during unit startup. **If a fuse blows or a breaker trips, always determine the reason. Do not arbitrarily install a larger fuse or breaker and do not, in any case, exceed the maximum size listed on the data label of the unit.**

### Blower Speed

For optimum system performance and comfort, it may be necessary to change the factory speed setting. See Table 1 below for factory settings. **NOTE:** This model has a High Efficiency ECM Motor with 5 speed taps.

### **WARNING:**

**To avoid electric shock, personal injury, or death, turn off the electric power at the disconnect or the main service panel before making any electrical connections.**

1. Disconnect all electrical power to the unit and remove the service panel.

### **CAUTION:**

**Label all wires prior to disconnection when servicing controls. Wiring errors can cause improper and dangerous operation. Verify proper operation after servicing.**

2. Locate the orange, black and red wires terminated to the blower motor. The orange wire controls the low speed cooling and heating operations, the black wire controls high speed cooling and heating operations and the red wire controls the electric heating operation.

### **CAUTION:**

**To avoid personal injury or property damage, make certain that the motor leads cannot come into contact with any metal components of the unit.**

3. Verify the required speed from the airflow data found in Table 1. Place appropriate wire on the appropriate motor speed tap for the required airflow.
4. Check all factory wiring per the unit wiring diagram and inspect the factory wiring connections to be sure none loosened during shipping or installation.

### **2-Speed Outdoor Fan Motor (Select Models)**

If the unit utilizes a 2-speed condenser fan motor, this motor will operate on low speed when in low cooling/heating, and on high speed when in high cooling/heating.

### **Ambient Sensor Mounting**

For optimum performance of the heat pump system, the ambient sensor (Figure 6, page 9) must be mounted on the outside of the unit.

1. Remove the mounting bracket and all hardware included in the packet.
2. Remove star bushing from 7/8" hole in corner panel of the unit.

Model Number	Motor Tap	External Static Pressure Drop (in WC)							
		0.1	0.2	0.3	0.4	0.5	0.6	0.7	0.8
X24K	TAP T1*	990	790	560	540				
	TAP T2**	1040	850	600	550	500			
	TAP T3	1080	920	800	720	680	620	570	520
	TAP T4***	1160	1100	1040	1000	960	900	850	820
	TAP T5	1330	1300	1250	1200	1170	1130	1080	1030
X36K	TAP T1*	1020	840	600	500				
	TAP T2	1060	900	750	700	650	600	540	500
	TAP T3**	1280	1240	1200	1180	1140	1100	1070	1010
	TAP T4***	1480	1450	1420	1390	1360	1320	1290	1240
	TAP T5	1580	1550	1520	1480	1450	1420	1380	1350
X48K	TAP T1*	1150	1090	1030	1000	950	900	850	800
	TAP T2	1300	1270	1240	1200	1160	1120	1090	1050
	TAP T3***	1460	1430	1400	1370	1340	1300	1250	1200
	TAP T4**	1520	1480	1450	1420	1390	1360	1330	1300
	TAP T5	1740	1710	1680	1650	1620	1590	1540	1500
X60K	TAP T1	1150	1100	1060	1030	980	950	900	870
	TAP T2*	1250	1200	1170	1150	1130	1100	1060	1020
	TAP T3***	1560	1530	1500	1470	1450	1420	1390	1360
	TAP T4**	1750	1700	1670	1630	1600	1580	1560	1530
	TAP T5	1960	1930	1900	1860	1830	1800	1770	1740

\* Denotes factory set low cooling & heating speed

\*\* Denotes factory set high cooling & heating speed

\*\*\* Denotes factory set electric heating speed

**Table 1. Airflow Data**



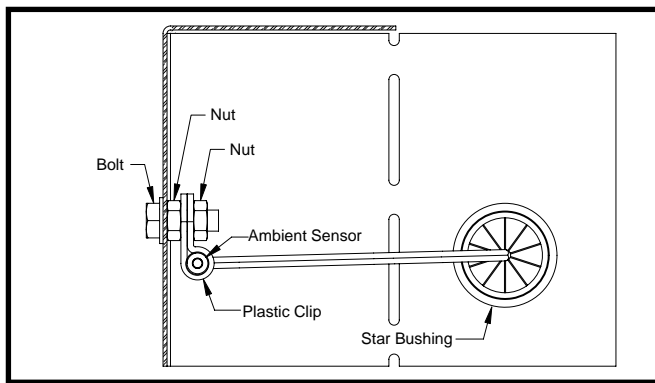

**Figure 6. Ambient Sensor Mounting**

3. Route the ambient sensor through the 7/8" hole in the corner panel of the unit, and then through the 7/8" hole in the mounting bracket.
4. Route the sensor through the star bushing. Use the star bushing to secure the mounting bracket to the unit.
5. Secure the ambient sensor inside the plastic clip and secure it to the mounting bracket with the screw and nut provided.
6. Install one spacer next between the plastic clip and mounting bracket.
7. Bend the mounting bracket into position. Install the mounting bracket to the unit using the screw in the corner panel.

### Demand Defrost Control

The demand defrost board controls the defrost cycle in response to ambient temperature, outdoor coil temperature and accumulated compressor run time. The heat pump is allowed to operate in the heating mode until the combination of outdoor ambient and outdoor coil temperatures indicate that defrosting is necessary, based on the programmed defrost curve. There are four preprogrammed defrost curves on the board.

- A jumper pin is used to switch between the different curves. The default jumper position is curve 1 and is the recommended setting for most standard applications. See Table 2 for additional defrost curves settings.
- The factory default setting does not include a 30 second compressor delay function and has a 40 ° F defrost terminate temperature. If additional defrost time is needed, a higher terminate temperature is available by selecting a different demand curve. **NOTE:** The 30 second compressor delay occurs when the unit enters defrost and exits defrost. The delay function is optional and based on the demand curve selected.
- The standard defrost cycle will terminate after 13 minutes and 39 seconds or when the coil temperature reaches its terminate temperature, whichever occurs first.
- The defrost board is equipped with a 5 minute Anti-Short Cycle Timer (ASCT). The compressor will not turn on until it reaches the minimum 5 minute off time.
- The control contains a forced - defrost feature, which places the system into defrost mode every 6 hours

and 4 minutes, unless the coil temperature is above the selected terminate temperature.

- The system can be manually forced into defrost mode at any time by shorting the **TEST** terminals on the demand defrost board together for more than 9 seconds. The coil temperature sensor does not need to be cold when the unit is forced into defrost. After the **TEST** input is shorted, the defrost mode will terminate in 13.7 minutes, if the coil temperature is above the terminate set-point, or when the **Y** input is removed, whichever occurs first.

**NOTE:** If a demand curve is selected which has a 30 second compressor time delay, the delay is reduced to 10 seconds in TEST mode.

Jumper Position	Minimum Time Between Defrosts (minutes)	Terminate Temperature (° F)	Compressor Delay Function
1	20	40	NO
2	20	40	YES
3	20	75	NO
4	20	75	YES

**Table 2. Demand Defrost Curve Profiles**

### Thermostat Connections

- This heat pump requires a 2-stage Cooling and 3 stage heating thermostat if electric heat is field installed. The heat-cool thermostat prevents simultaneous operation of the heating and cooling units and is equipped with an ON-AUTO fan mode that allows the home owner to operate the indoor blower when only air circulation is desired.
- The control circuit wiring must comply with the current provisions of the NEC (ANSI/NFPA 70) and with applicable local codes having jurisdiction. Thermostat connections should be made in accordance with the instructions supplied with the thermostat and the indoor equipment.
- The low voltage wires must be properly connected to the units low voltage terminal block.
  1. Route 24V control wires through the sealing grommet (Figure 5, page 7) near the power entrance.
  2. Connect the control wires to the defrost board and blower relay wire (Figure 7, page 10).
- Several thermostat options are available depending on the accessories installed with the unit. Select a thermostat that operates in conjunction with the installed accessories.
- The thermostat should be mounted about 5 feet above the floor on an inside wall. DO NOT install the thermostat on an outside wall or any other location where its operation may be adversely affected by radiant heat from fireplaces, sunlight, or lighting fixtures, and convective heat from warm air registers or electrical appliances. Refer to the thermostat manufacturer's instruction sheet for detailed mounting information.

**Electric Heat Package (optional)**

This heat pump is shipped without an auxiliary electric heat kit installed. If electric heat is desired, an accessory Heater Kit must be field installed. See Specifications Sheet for available kits and their application.

- Select the correct size heat package for the installation.
- Follow installation instructions provided with each heater kit.
- Installation is most easily accomplished before making duct or electrical connections.
- Refer to Table 1 (page 8) for blower speeds

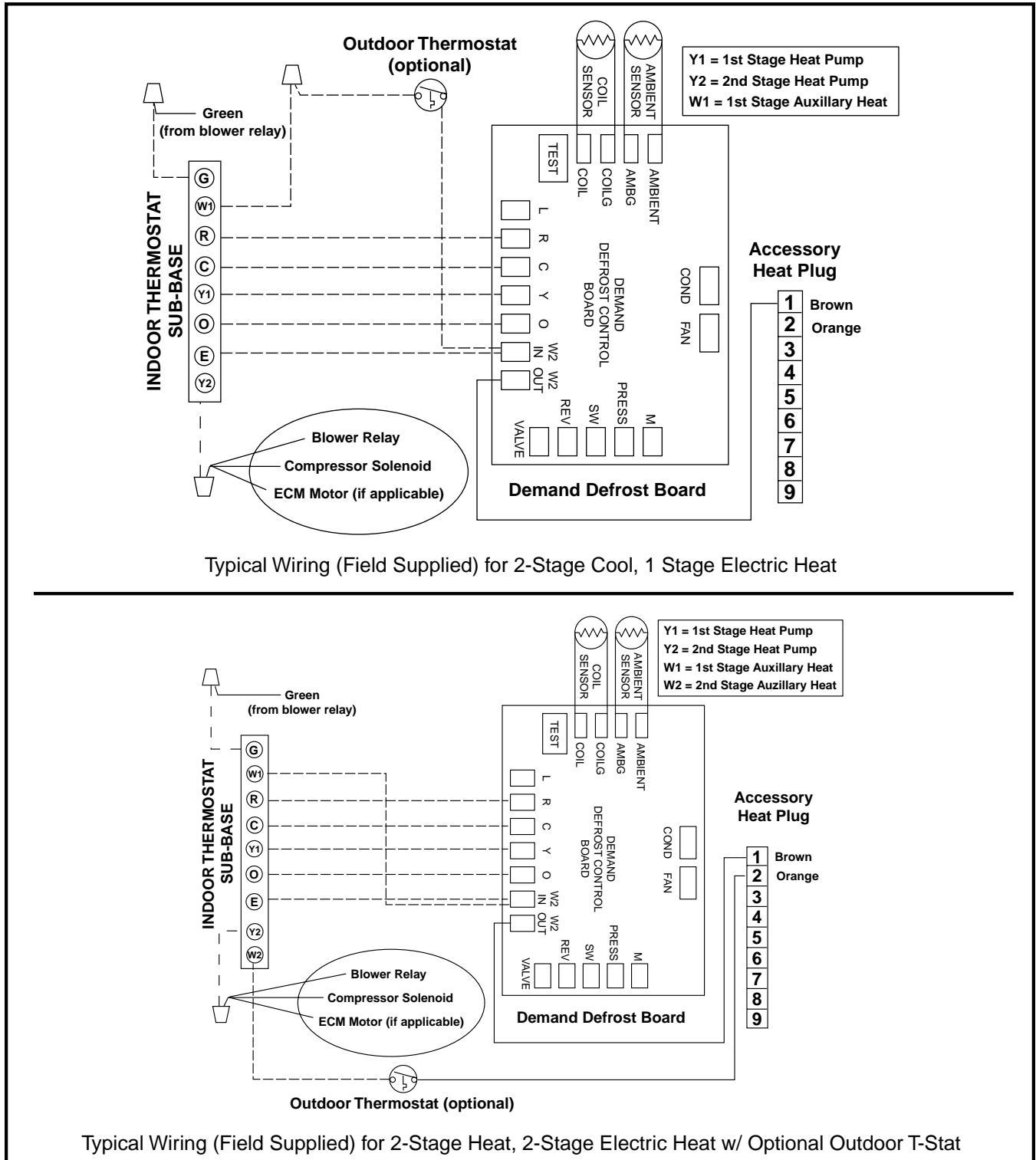

**Figure 7. Typical Heat Pump Thermostat Connections**

## STARTUP & ADJUSTMENTS

### Pre-Start Checklist

The following check list should be observed prior to starting the unit.

- √ Is the unit level? Unit should be level or slightly slanted toward the drain for proper condensate drainage.
- √ Is the unit installed with the proper clearances as listed in Figure 1 (page 4)?
- √ Is the wiring correct according to the wiring diagram and electrical codes?
- √ Are all the wiring connections tight? Check the condenser fan to make sure it turns freely.
- √ Is the overcurrent protection properly sized?
- √ Is the thermostat wired correctly? Is it installed in a proper location?

### Start-Up Procedure

The control circuit consists of an anti-short cycle timer that will not let the compressor start at power up before five minutes have elapsed.

1. Set the system mode to OFF and the temperature mode to its highest setting.
2. Turn power on at the disconnect switch.
3. Set the system mode to ON or COOL.
4. Set the temperature mode below room temperature. Verify that the indoor blower, outdoor fan, and compressor energize and the cooling function starts.
5. Verify the discharge air grilles are adjusted and the system air is balanced.
6. Verify the duct work has no air leaks.
7. Verify the condensate drain is installed correctly and functions properly.
8. Set the temperature mode above room temperature. The unit should stop.
9. Instruct the homeowner on unit and thermostat operation and filter servicing.

### Air Circulation

Leave the thermostat system mode on OFF, and set the fan mode to ON. Blower should run continuously. Check the air delivery at the supply registers and adjust register openings for balanced air distribution. Examine ductwork for leaks or obstruction if insufficient air is detected.

Set the thermostat fan mode to AUTO. The blower should stop running.

### System Heating

Set the thermostat system mode to HEAT and the fan mode to AUTO. Change the thermostat temperature selector above the existing room temperature and check for the discharge of warm air at the supply registers.

### System Cooling

Set the thermostat's system mode to COOL and the fan mode to AUTO. Change the thermostat temperature selector below the existing room temperature. Allow the cooling system to operate for several minutes and check for the discharge of cool air at the supply registers.

### Short Cycle Protection

The control circuit is equipped with a time-delay feature for protection against short cycling. With the system operating in the cooling mode, gradually raise the thermostat temperature setting until the system de-energizes. Immediately lower the thermostat temperature to the original setting and verify that the indoor blower is energized. After approximately 5 minutes, the compressor and the outdoor fan will energize.

### Emergency Heat

1. Set the thermostat's system mode to EM HT and the fan mode to AUTO (intermittent air) or ON (continuous air).
2. Set the thermostat's temperature selector above the existing room temperature and check the following:
  - The thermostat auxiliary heat light (RED) is on.
  - The AC compressor and the fan should not run; low voltage circuit remains energized.
  - The blower runs according to the thermostat's fan mode setting.

### Adjustment of Refrigerant Charge

---

## CAUTION:

---

**This heat pump contains liquid and gaseous refrigerant under pressure. Adjustment of refrigerant charge should only be attempted by qualified, trained personnel thoroughly familiar with the equipment and safe responsible refrigerant handling procedures. Under no circumstances should the homeowner attempt to install and/or service this equipment. Failure to comply with this warning could result in equipment damage, personal injury, or death.**

---

- The unit must be charged while both first and second stages are operating.
- To achieve rated capacity and efficiency the compressor must be exposed to refrigerant for at least 24 hours prior to running and then must be run for a minimum of 12 hours. If Charging in Cooling Mode, see Refrigerant Charging Charts (Figures 9 - 12, pages 14 & 15).

### Charging the Unit in AC Mode with Outdoor Temperatures Above 65F

1. With the system operating at steady-state, measure the liquid refrigerant pressure in psig at the service valve.
2. Measure the liquid refrigerant temperature (° F) at the service valve.
3. For the temperature measured, determine the required liquid refrigerant pressure from the appropriate charging charts.
  - If the pressure measured in step 1 is greater than the required liquid refrigerant pressure determined in step 3, then there is too much charge in the system. Remove refrigerant and repeat steps 1 through 3 until the system is correctly charged.

- If the pressure measured in step 1 is less than the required liquid refrigerant pressure determined in step 3, then there is too little charge in the system. Add refrigerant and repeat steps 1 through 3 until the system is correctly charged.

### Charging the Unit in Heating Mode

1. Evacuate the refrigerant system.
2. Weigh in the proper charge as indicated on the unit label. Unit charge **MUST** be verified in cooling season.
3. Verify the unit is operating properly according to the System Heating section on page 11.

### Forced Defrost Mode (Field Test)

- When the **TEST** terminals are shorted with the **Y** input active and pressure switches closed, the ACST will be eliminated and the compressor contactor output energizes within 2 seconds. When the **TEST** terminals are shorted for more than 9 seconds with the **Y** input active, the control will be placed into a forced defrost mode.

**NOTE:** The coil temperature sensor does not need to be cold when the unit is forced into defrost.

- After the **TEST** input is shorted, the defrost mode will terminate in 13.7 minutes or less or when the coil temperature is above the terminate set point or when the thermostat **Y** input is removed, whichever occurs first.

### Anti Short Cycle Timer Test

The 5 minute time delay feature can be bypassed by shorting the **TEST** pins together.

#### Heating Mode

When the **TEST** pins are shorted together for more than 1 second, the control will switch between defrost mode and heating mode as described in the Forced Defrost Mode procedure section.

#### Cooling Mode

When the **TEST** pins are shorted together for more than 1 second, the Anti Short Cycle Timer will be bypassed.

## COMPONENT FUNCTIONS

### Low Pressure Switch

The low pressure switch is factory installed and located in the suction line internal to the unit. The switch is designed to protect the compressor if a loss of charge occurs. Under normal conditions, the switch is closed.

If the suction pressure falls below 5 psig, then the switch will open and de-energize the unit. The switch will close again once the suction pressure increases above 20 psig. The low pressure switch interrupts the thermostat inputs to the unit. **NOTE:** When the switch opens and then closes, there will be a 5 minute short cycling delay before the unit can energize.

### High Pressure Switch

The high pressure switch is factory installed and located in the compressor discharge line internal to the unit. The

switch is designed to de-energize the system when very high pressures occur during abnormal conditions. Under normal conditions, the switch is closed.

If the discharge pressure rises above 650 psig, the switch will open and de-energize the unit. The switch will close again once the discharge pressure decreases to 460 psig. The high pressure switch interrupts the thermostat inputs to the unit. **NOTE:** When the switch opens and then closes, there will be a 5 minute short cycling delay before the unit can energize.

## UNIT MAINTENANCE

### **WARNING:**

**To prevent electrical shock, personal injury, or death, disconnect all electrical power to the unit before performing any maintenance or service. The unit may have more than one electrical supply.**

Proper maintenance is important to achieve optimum performance from the heat pump. The ability to properly perform maintenance on this equipment requires certain mechanical skills and tools. If you do not possess these skills, contact your dealer for maintenance. Consult your local dealer about the availability of maintenance contracts. Routine maintenance should include the following:

- Inspect and clean or replace air filters at the beginning of each heating and cooling season, or more frequently if required.
- Inspect the condensate drain and outdoor coil at the beginning of each cooling season. Remove any debris. Clean the outdoor coil and louvers as necessary using a mild detergent and water. Rinse thoroughly with water.
- Inspect the electrical connections for tightness at the beginning of each heating and cooling season. Service as necessary.

### **CAUTION:**

**The unit should never be operated without a filter in the return air system. Replace disposable filters with the same type and size.**

- Do not attempt to add additional oil to motors unequipped with oil tubes. The compressor is hermetically sealed at the factory and does not require lubrication.

## FIGURES & TABLES

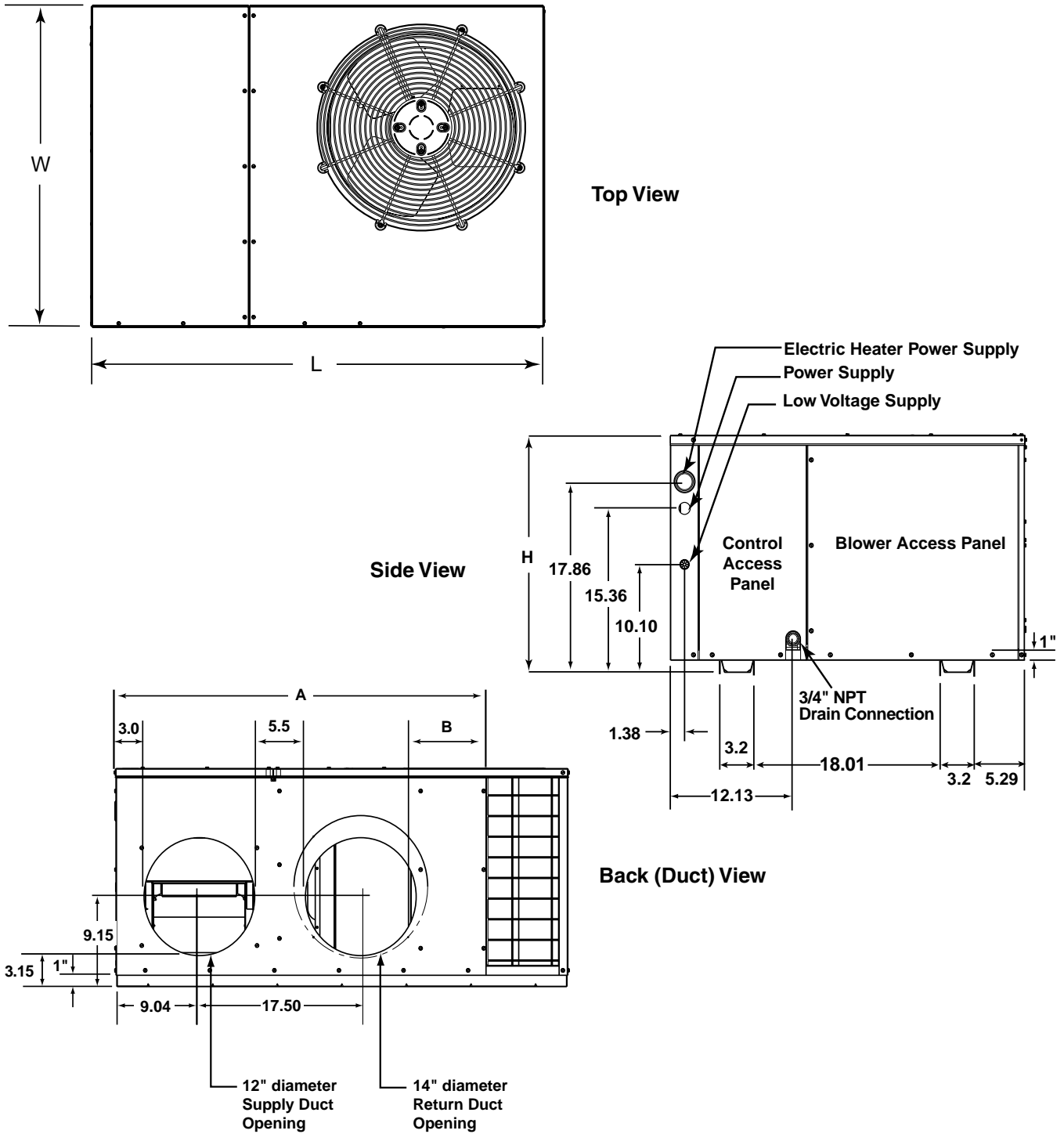

**Figure 8. Unit Dimensions**

Model Number	Length (L)	Width (W)	Height (H)	A	B
X24K	49	35	30.2	40.15	7.61
X36K	49	35	30.2	35.02	2.48
X48K	49	35	38.2	35.02	2.48
X60K	63	35	38.2	35.02	2.48

**Table 3. Physical Data**

# REFRIGERANT CHARGING CHARTS - COOLING MODE

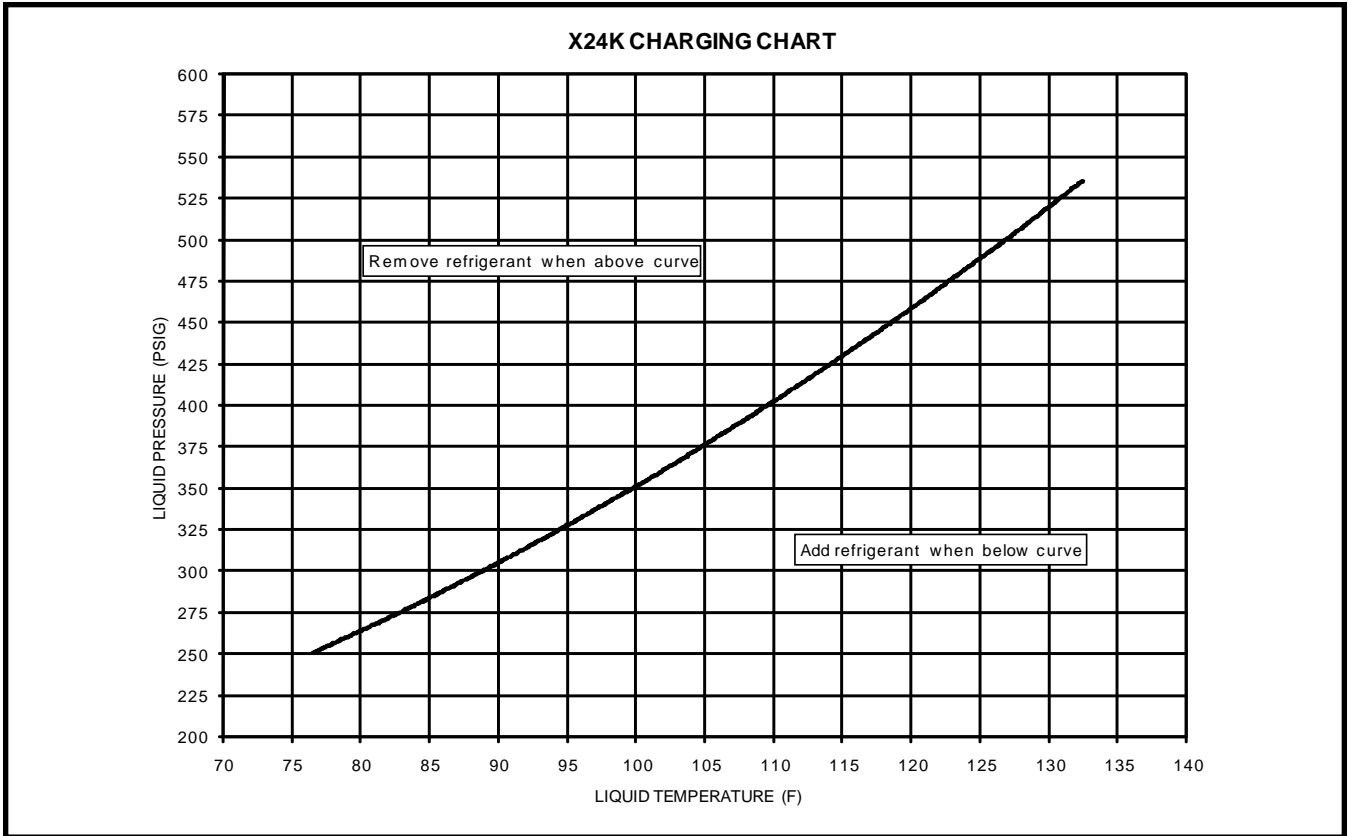

Figure 9. Charging Chart for 2 Ton Units

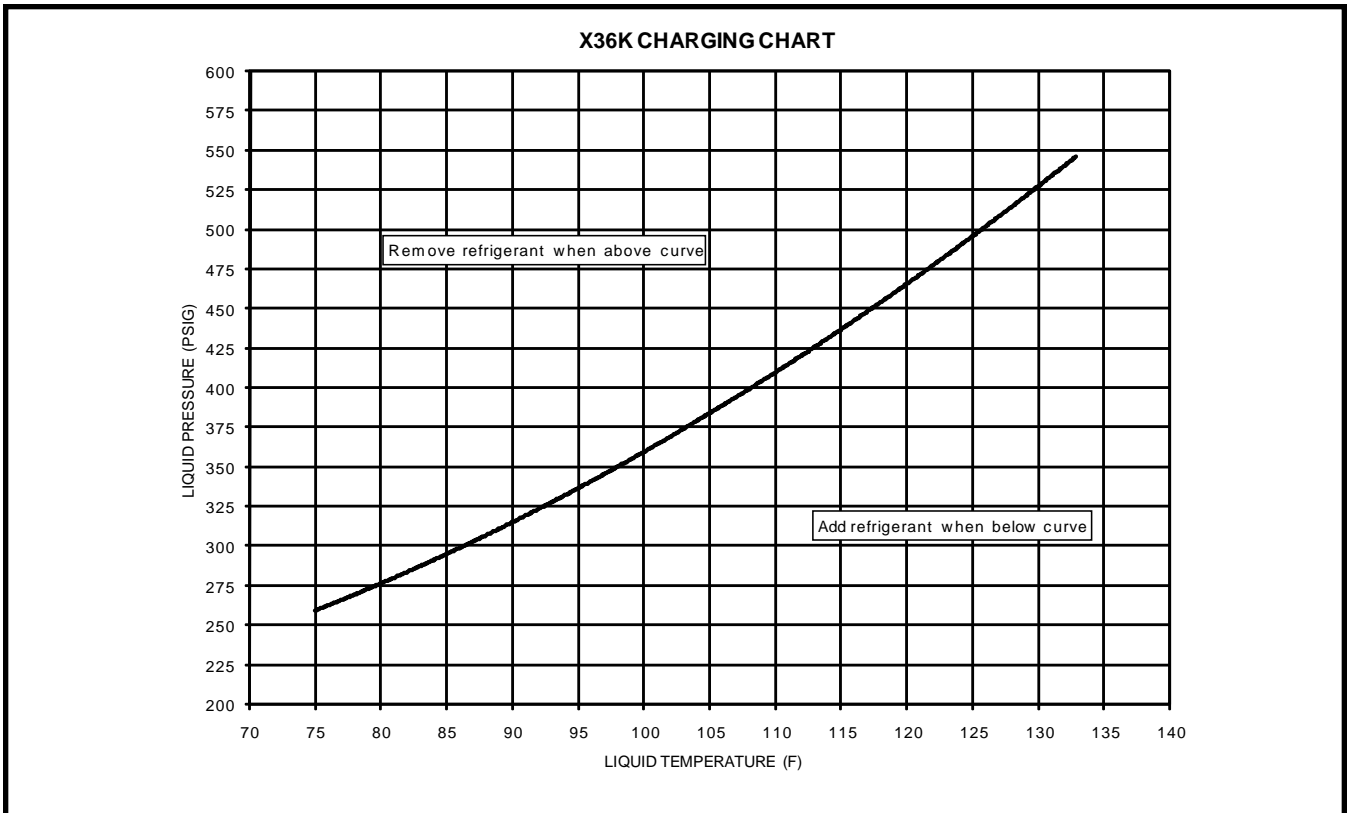
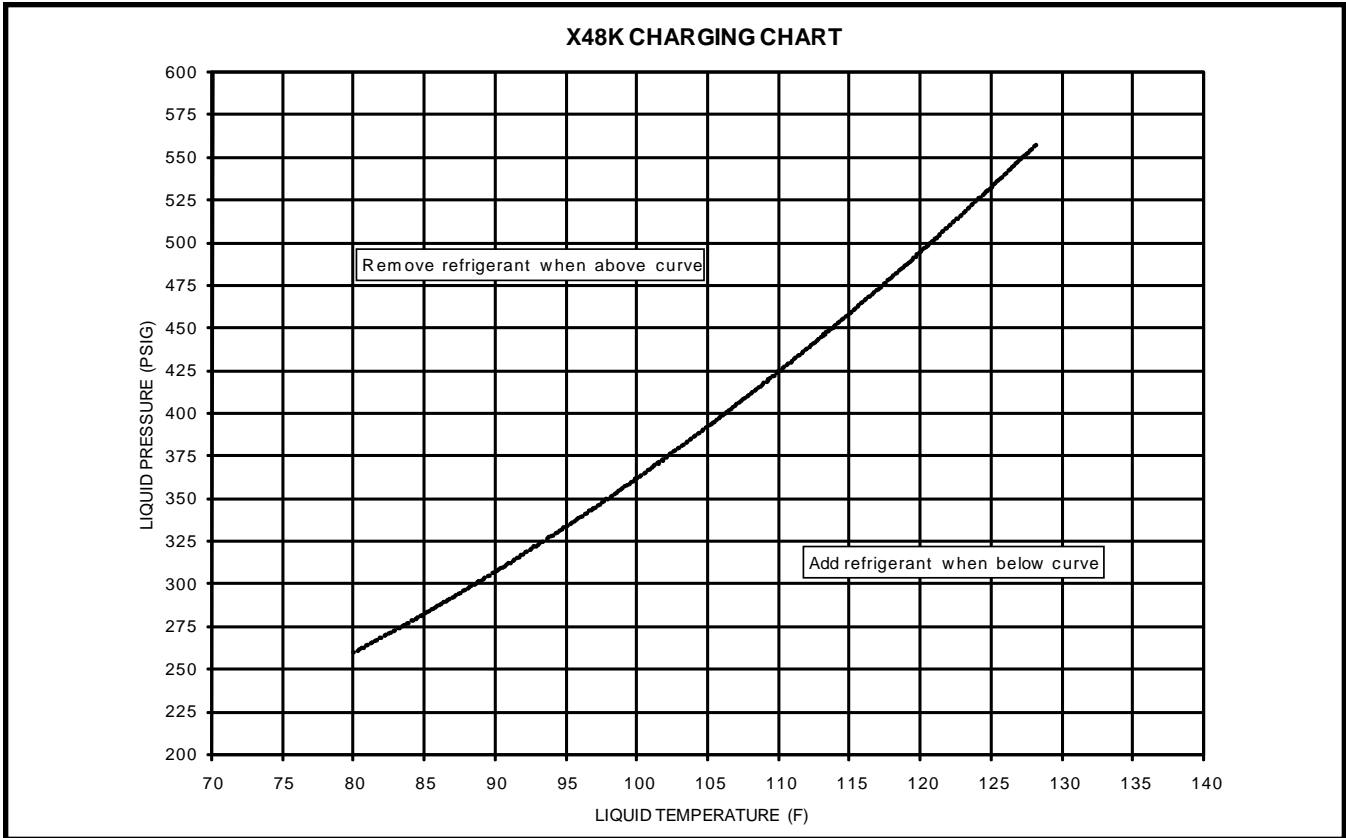
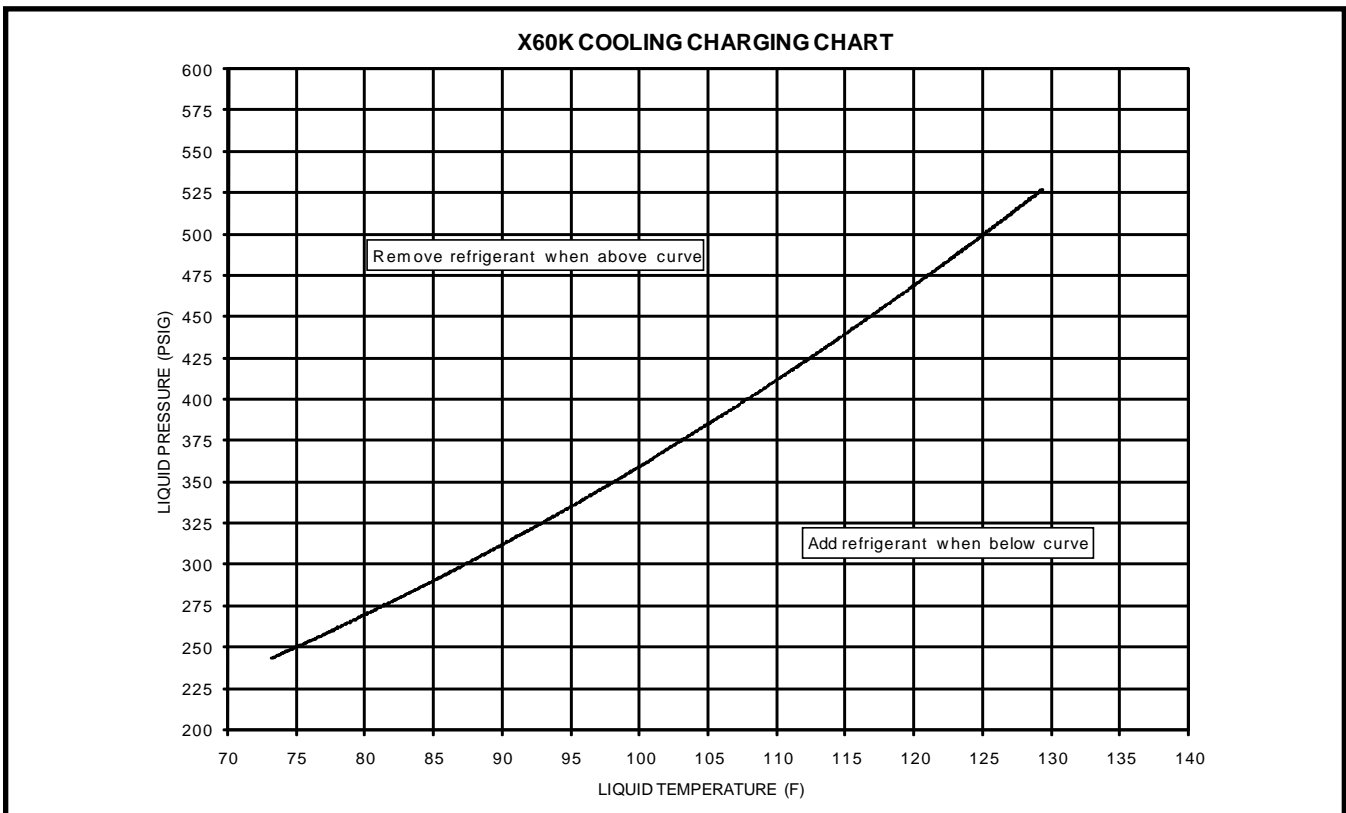

Figure 10. Charging Chart for 3 Ton Units

## REFRIGERANT CHARGING CHARTS - COOLING MODE



**Figure 11. Charging Chart for 4 Ton Units**



**Figure 12. Charging Chart for 5 Ton Units**

# WIRING DIAGRAMS

## WIRING DIAGRAM

**Q5RF/PPH2RF SERIES SMALL PACKAGE H/P W/DEMAND DEFROST 2 TON AND 3 TON 208/230V 60HZ/SINGLE PHASE**

**NOTES:**

1. Disconnect all power before servicing.
2. For supply connections use copper conductors only.
3. Not suitable on systems that exceed 150V to ground.
4. For replacement wires use conductors suitable for 105°C.
5. Unit requires a two stage cooling/heating thermostat which uses "G" to call for blower.

1. Couper le courant avant de faire le lettrine.
2. Employez uniquement des conducteurs en cuivre.
3. Ne convient pas aux installations de plus de 150V a la terre.

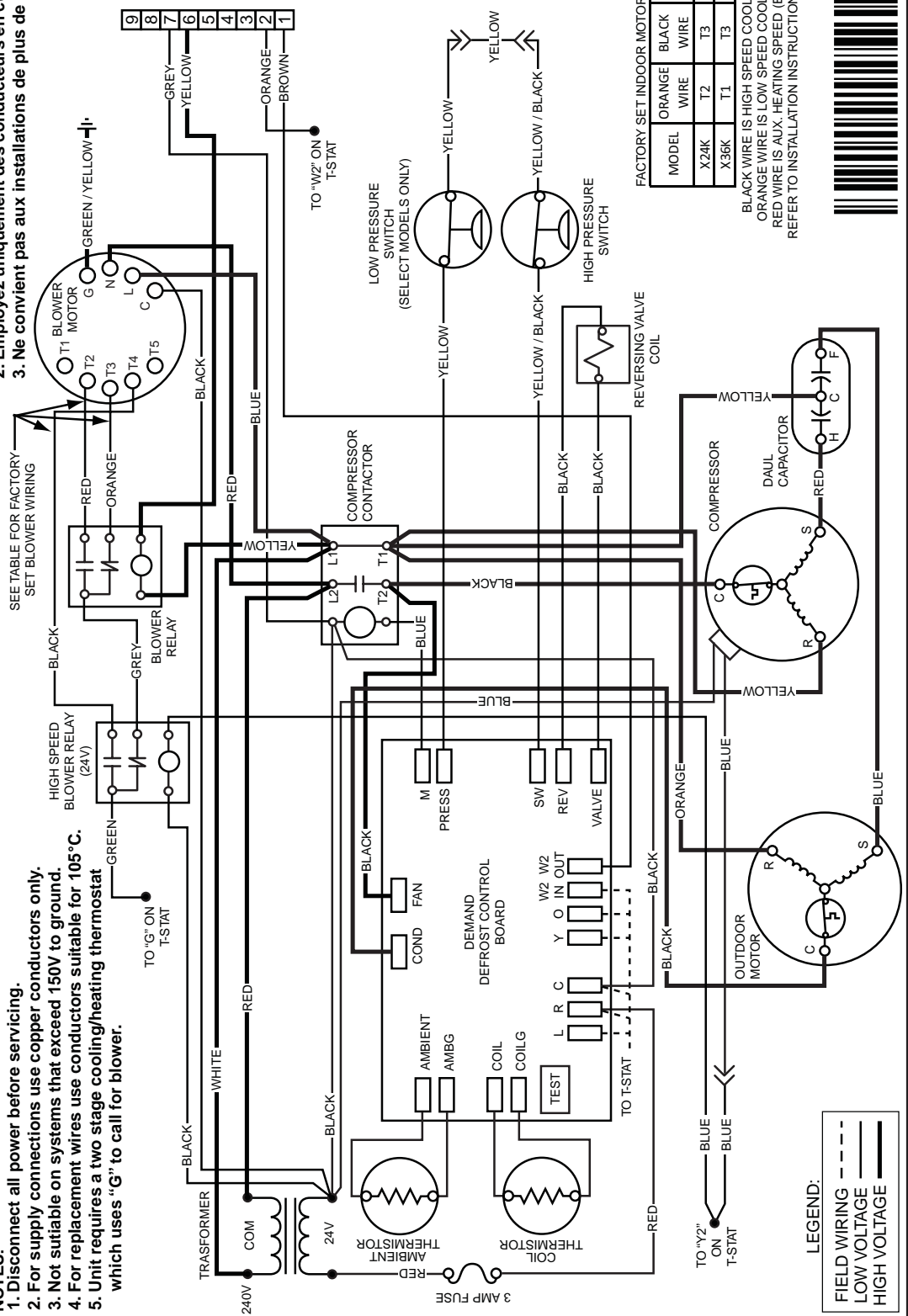

Figure 13. Wiring Diagram - 2 & 3 Ton Units



# WIRING DIAGRAM

**Q5RF/PPH2RF SERIES SMALL PACKAGE H/P W/DEMAND DEFROST 4 TON AND 5 TON**      **208/230V**      **60HZ/SINGLE PHASE**

1. Couper le courant avant de faire letretine.
2. Employez uniquement des conducteurs en cuiver.
3. Ne convient pas aux installations de plus de 150V a la terre.

1. Disconnect all power before servicing.
2. For supply connections use copper conductors only.
3. Not suitable on systems that exceed 150V to ground.
4. For replacement wires use conductors suitable for 105°C.
5. Unit requires a two stage cooling/heating thermostat which uses "G" to call for blower.

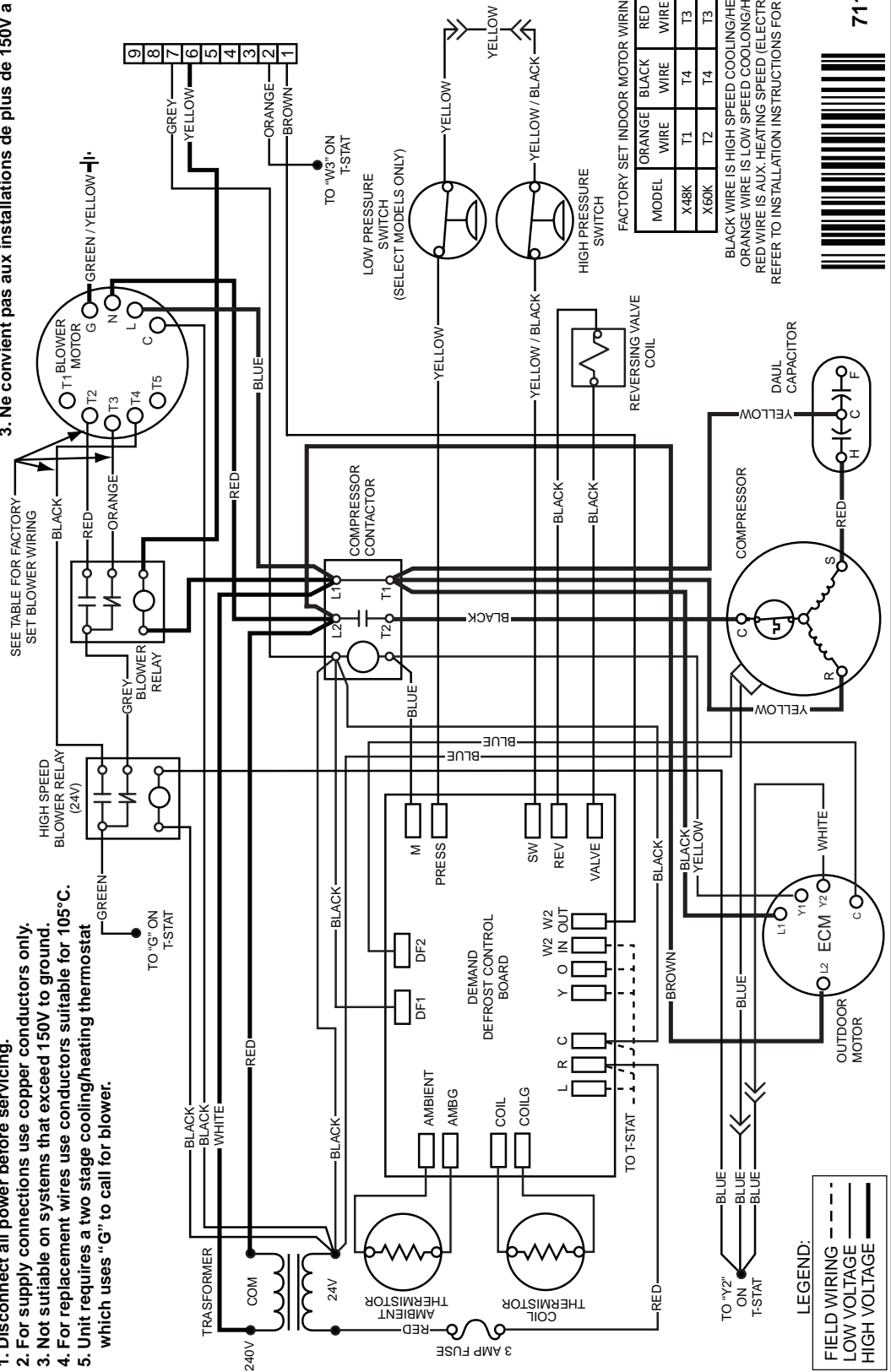

FACTORY SET INDOOR MOTOR WIRING

MODEL	ORANGE WIRE	BLACK WIRE	RED WIRE
X48K	T1	T4	T3
X60K	T2	T4	T3

BLACK WIRE IS HIGH SPEED COOLING/HEATING  
 ORANGE WIRE IS LOW SPEED COOLING/HEATING  
 RED WIRE IS AUX. HEATING SPEED (ELECTRIC HEAT)  
 REFER TO INSTALLATION INSTRUCTIONS FOR CFM DATA

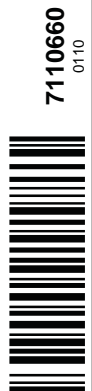

Figure 14. Wiring Diagram - 4 & 5 Ton Units





## INSTALLATION / PERFORMANCE CHECK LIST

<b>INSTALLATION ADDRESS:</b>		
CITY _____	STATE _____	
UNIT MODEL # _____		
UNIT SERIAL # _____		
Unit Installed Minimum clearances per Figure 1 (page 4)?	YES	NO
<b>INSTALLER NAME:</b>		
CITY _____	STATE _____	

ELECTRICAL SYSTEM:		
Electrical connections tight?	YES	NO
Line voltage polarity correct?	YES	NO
Rated Voltage: _____ VOLTS		
L1-L2 Volts: _____ VOLTS		
Has the thermostat been calibrated?	YES	NO
Is the thermostat level?	YES	NO
Is the heat anticipator setting correct?(If Applicable)	YES	NO

REFRIGERATION SYSTEM:		
Was unit given 24 hr warm up period for crankcase heaters (if applicable)?	YES	NO
Stage-1 Liquid Pressure (high side) _____		
Stage-1 Suction Pressure (low side) _____		
Has the owner's information been reviewed with the customer?	YES	NO
Has the Literature Package been left with the unit?	YES	NO

**⚠ WARNING:**

**PROPOSITION 65 WARNING:** This product contains chemicals known to the state of California to cause cancer, birth defects or other reproductive harm.



**NORDYNE**  
COMPLETE COMFORT. GENUINE VALUE.



Specifications & illustrations subject to change without notice or incurring obligations.  
O' Fallon, MO | Printed in U.S.A. (06/11)

**709185B** (Replaces 709185A)